



KWIK ZIP Graphic System

MEASUREMENT REQUIREMENTS

MEASUREMENTS: EPIC Media Group requires that all Trucks/Trailers or Rear Doors are properly measured with the respective measurement forms, including a full view picture of each truck side or rear door with a Truck/Trailer ID or any other reference number. Also if there's any hardware that sticks out more than a quarter of an inch and may interfere with the application of the Frame System, the customer is responsible to remove it. Any further modifications that **EPIC** has to perform will slow down the installation process and require an additional fee.

Measurements are the most important part of the production process, we need everyone to provide the correct and accurate measurements for each Truck/Trailer or Rear Door. **EPIC** is not responsible for any wrong measurement provided by the customer or any other third party. Please follow all instructions from the appropriate form.

GETTING HELP: Our goal is to make sure that the measurement process is done correctly, we have created measurement forms for the most common type of vehicles, if you think that our measurement forms are not appropriate for your needs, we will customize one for you.

REMEMBER: EPIC IS JUST A PHONE CALL AWAY!

Any questions, please call: **EPIC Media Group** at 310-827-8800 • Fax: 310-827-5800

READ BEFORE MEASURING

The KWIK ZIP™
Frame by:



SOME SUGGESTIONS FOR MEASURING... PLEASE READ!

CORRECT, ACCURATE MEASUREMENTS ARE THE MOST IMPORTANT PART OF THE PRODUCTION PROCESS. PLEASE FOLLOW ALL DIRECTIONS VERY CAREFULLY.

You will need:

25' tape for vertical measurements



100' tape for horizontal measurements



*Make sure the end of the 100' tape is pulled out straight to get the first inch of measurement.



Piece of KWIK ZIP Frame

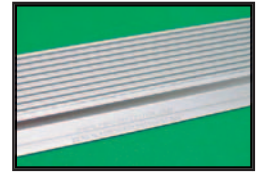

*This is Helpful, but not necessary

3/4" of clearance from edge of rivet to edge of rivet is required.

Determine where you have the 3/4" necessary clearance and measure from that outermost identified point.

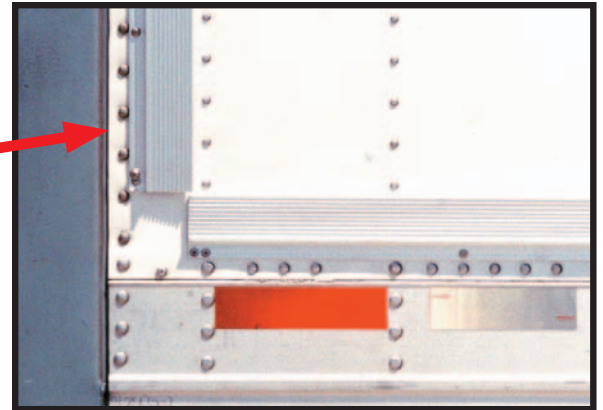
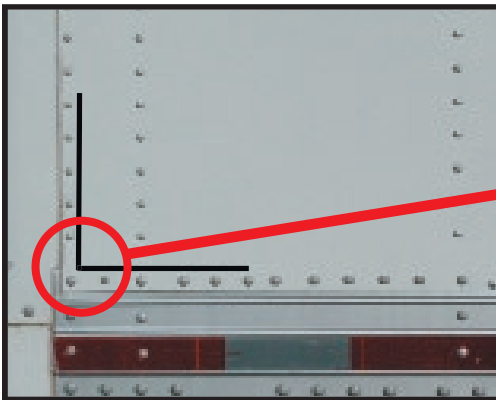

*Example of Frame Placement

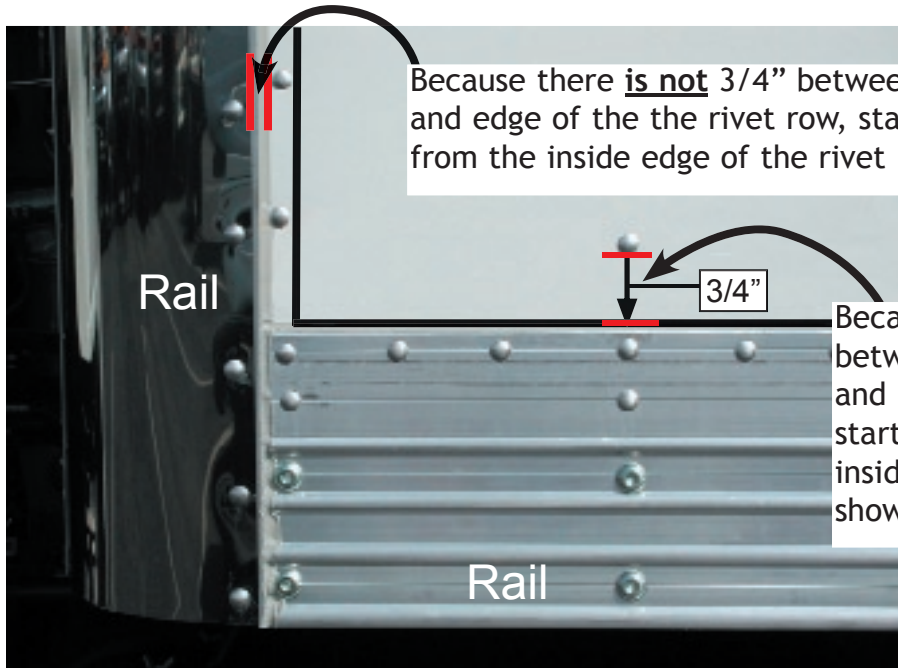









STEP 1: Company information

COMPANY:	CUSTOMER NAME:
DIST. CENTER ADDRESS:	
MEASURED BY:	DATE:
PHONE:	FAX:
NOTES:	

STEP 2: Truck ID

UNIT #:
LIC. #:
VIN #:
MAKE:
YEAR BUILT:
Back door <input type="checkbox"/> SWING <input type="checkbox"/> ROLL UP

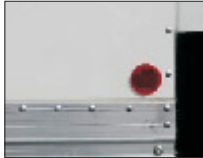
STEP 3: Please answer the following questions by checking the appropriate box

		YES	NO
1: Does the truck have horizontal ribs or corrugations?	 	<input type="checkbox"/>	<input type="checkbox"/>
2: Is the truck side flat, aluminum? (it would have lots of rivets)		<input type="checkbox"/>	<input type="checkbox"/>
3: Is the truck side FRP? (Fiberglass Reinforced Plywood, will have few rivets)		<input type="checkbox"/>	<input type="checkbox"/>
4: Is there any damage where the frame will lay: Driver's side? Passenger side?	 	<input type="checkbox"/>	<input type="checkbox"/>
5: Is the top front corner of the trailer bull-nosed?		<input type="checkbox"/>	<input type="checkbox"/>
6: Are there any reflectors that need to be relocated? HAZMAT signs?	 	<input type="checkbox"/>	<input type="checkbox"/>
7: Is there any conspicuity tape where the frame will lay?		<input type="checkbox"/>	<input type="checkbox"/>

STEP 1: Company information

COMPANY:	CUSTOMER NAME:
DIST. CENTER ADDRESS:	
MEASURED BY:	DATE:
PHONE:	FAX:
NOTES:	

STEP 2: Truck information

UNIT #:	LIC. #:
VIN #:	
MAKE:	YEAR BUILT:
TRUCK SIZE <input type="text"/> Ft.	Back door <input type="checkbox"/> SWING <input type="checkbox"/> ROLL UP
Truck has ribs <input type="checkbox"/> Y <input type="checkbox"/> N	...or corrugations <input type="checkbox"/> Y <input type="checkbox"/> N
Flat aluminum <input type="checkbox"/> Y <input type="checkbox"/> N	Bull-nose <input type="checkbox"/> Y <input type="checkbox"/> N
Has reflectors <input type="checkbox"/> Y <input type="checkbox"/> N	...or hazmat signs <input type="checkbox"/> Y <input type="checkbox"/> N
Damaged driver, <input type="checkbox"/> Y <input type="checkbox"/> N	...or curb side <input type="checkbox"/> Y <input type="checkbox"/> N

STEP 4: Physically take all measurements 1 - 2, and complete in FEET, INCHES and FRACTIONS! CRITICAL: Specify to the 1/8 of an inch.

DECAL MEASUREMENTS

FRACTIONS
No rounding up

HEIGHT:

1	<input type="text"/>	<input type="text"/>	<input type="text"/>	<input type="text"/>
	FEET	INCHES	FRACTION	

WIDTH:

2	<input type="text"/>	<input type="text"/>	<input type="text"/>	<input type="text"/>
----------	----------------------	----------------------	----------------------	----------------------

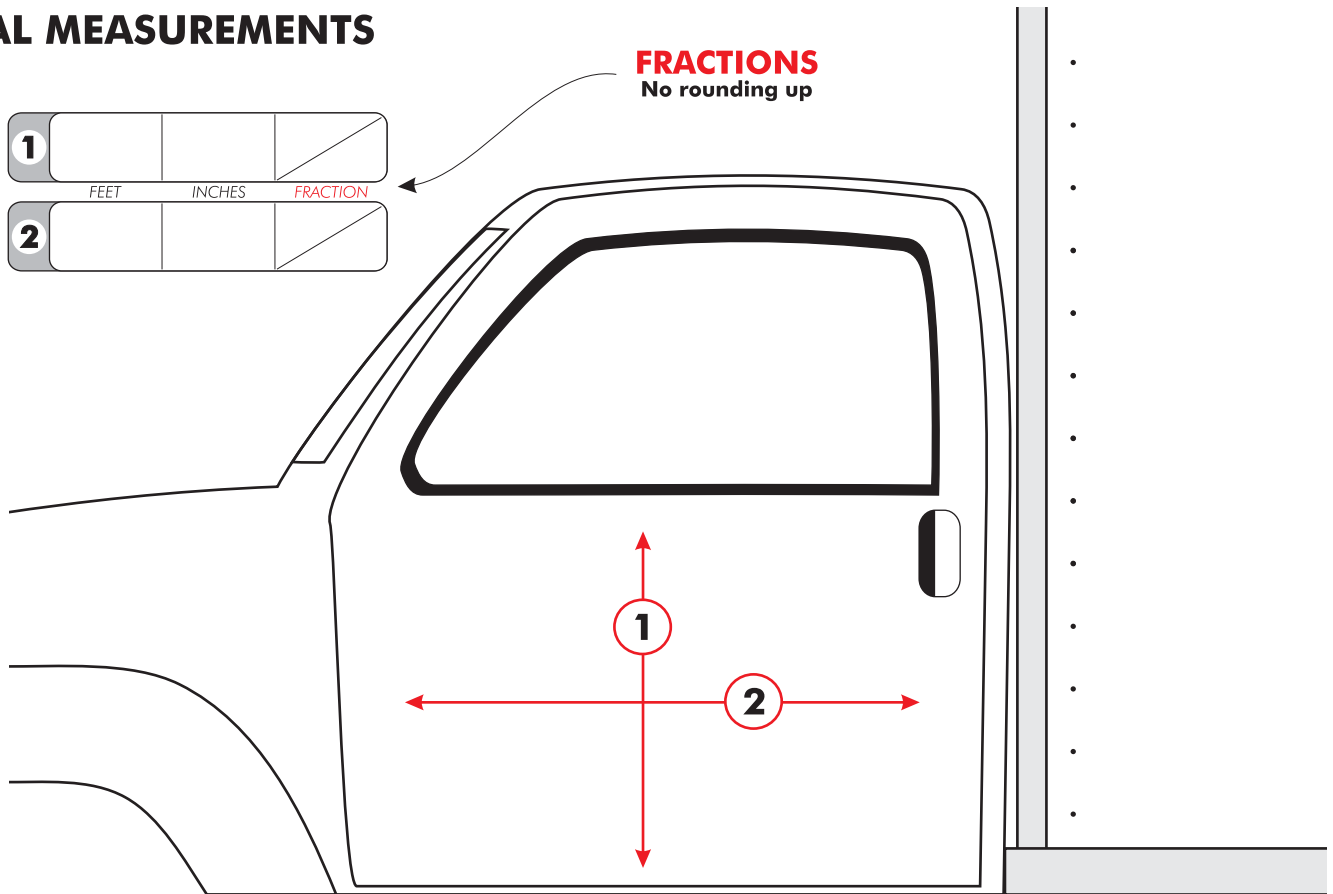

GRAPHIC PLACEMENT

 ONE SIDE ONLY

 SAME GRAPHIC BOTH SIDES

DRIVER GRAPHIC NAME _____

CURB GRAPHIC NAME _____

ADDITIONAL NOTES

QUESTIONS?